

SWIVEL BACK 275 manual







Cod. MOBACK07109VA

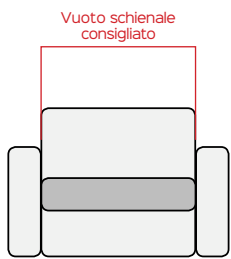

DESIGN IN MOVIMENTO



 <p>Vuoto schienale consigliato</p>
Vuoto standard (mm)
Vuoto schienale consigliato
540
650

 <p>Manuale</p>	 <p>2kg+/-100gr</p>	 <p>275 mm</p>	 <p>Poltrone</p>	 <p>Divani</p>	 <p>Portata: 40kg</p>	 <p>Cicli: 50.000</p>	2 ANNI Garanzia
--	--	---	---	---	--	--	---------------------------

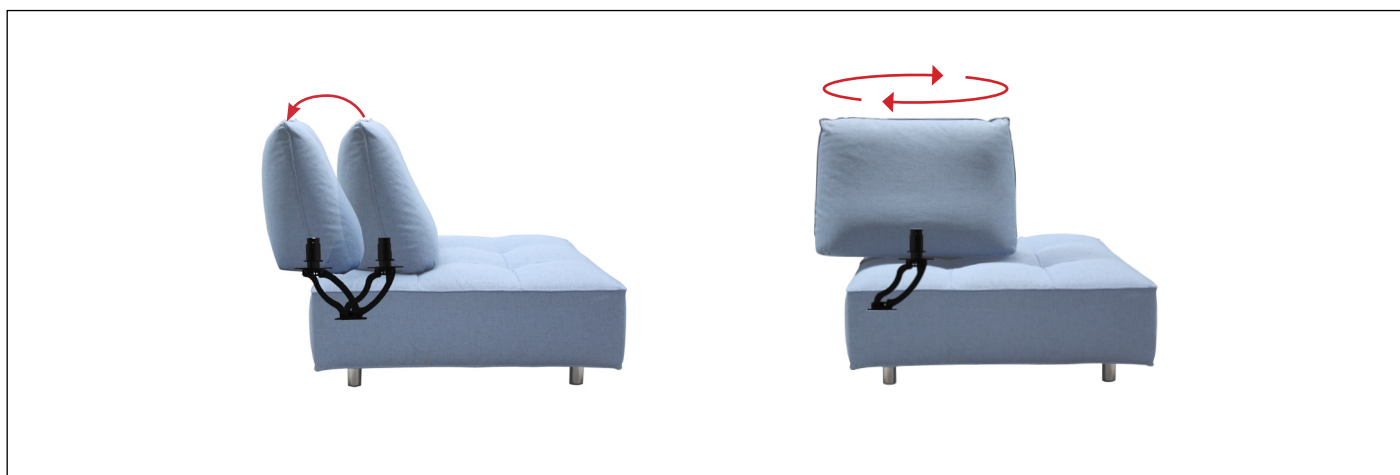

Benefit: La continua ricerca e lo sviluppo di nuovi prodotti ha dato vita ad questo nuovo meccanismo che unisce le proprietà del nostro Mitico migliorandole con un anello rotante.

Infatti oltre a poter muovere lo schienale indietro e avanti (275mm) è possibile farlo ruotare di 360° così da poter personalizzare l'imbottito a proprio piacimento.

Optional

ACCESSORI



FINITURE

Motionitalia Design and quality Made in Italy

Headquarters: via Navicella 26, 47122 Forlì (FC) Tel.+39 0543 77 47 68 Fax.+39 0543 79 84 09 www.motionitalia.com info@motionitalia.com

Il produttore si riserva il diritto di modificare, in qualsiasi momento e senza preavviso, le specifiche tecniche dei propri prodotti

SWIVEL BACK 275 manual

Code MOBACK07109VA



DESIGN IN MOVIMENTO



Standard sizes (mm)
Suggested size for the Backrest
540
650

Manual	2kg+/-100gr	275 mm	Armchairs	Sofas	Load:40kg	Cycles:50.000	2YEARS Warranty
--------	-------------	--------	-----------	-------	-----------	---------------	------------------------

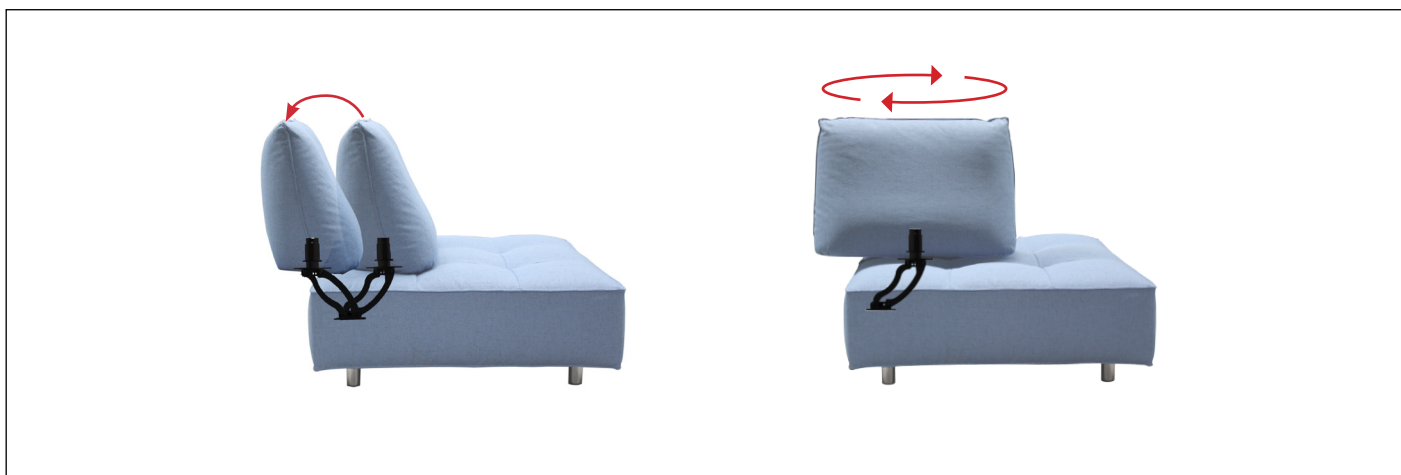

Benefit: Endless research and developments gave birth to this new mechanism which combines the features of our Mitico, improving them with a rotating ring. In fact, in addition of the back and

forward movement of the backrest (275mm), it's possible also to have a 360° rotation. In this way the upholstery can be completely customized.

Optional



Motionitalia Design and quality Made in Italy

Headquarters: via Navicella 26, 47122 Forlì (FC) Tel.+39 0543 774768 Fax.+39 0543 798409 www.motionitalia.com info@motionitalia.com

The producer reserves the right to modify, at any moment and without notice, the technical specification of its products